

GTDU - U-BOLT GROUNDING CLAMP (1 CONDUCTOR)

GTDU 3" IPS 4-2/0

Description

Purpose: Connection between ground rod to cable or IPS tube-cable. Suitable for COPPERSTEEL or copper cables.

Characteristics: Tightening connection. High electrical conductivity and corrosion resistant. It allows you to connect a cable, at 90° in relation to the rod / IPS tube.

Application: Grounding systems in general (power distribution systems, grounding grids, residential, building and industrial grounding, grounding in telecommunication networks, grounding in substations).

Material: Copper alloy clamp, fittings in copper alloy or electrolytic zinc plated steel.

Application Tool: Spanner set or open-ended wrench.

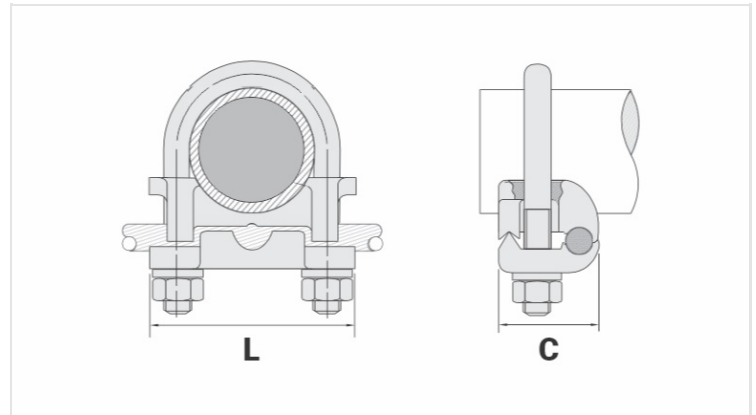
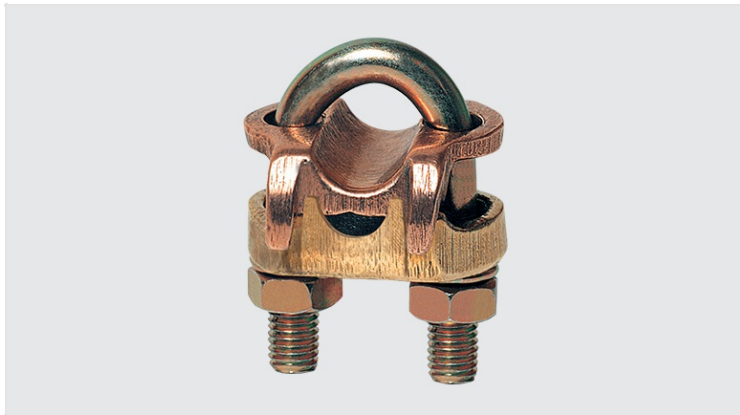

Datasheet

Conductor

AWG/MCM 4 - 2/0

mm² 16 - 70

Ground Rod Nominal Diameter (inches)

-

IPS Tube

3"

Accessory Material

Dimensions

L 125,0

A

C 45,0

Parafuso "U" M10

Figura 1

Package

Qtd / Emb

Peso Unit. (g)