

**CCA - WEDGE TYPE CONNECTOR FOR GROUNDING**

CCA-12-35

**Description**

**Purpose:** Connection between ground rod to cable. Suitable for COPPERSTEEL or copper cables.

**Characteristics:** Spring system connection (permanent tightening). High resistance to corrosion. Easy application. Supplied with antioxidant compound INTELTRON-Cu.

**Application:** Grounding systems in general (power distribution systems, grounding grids, residential, building and industrial grounding), grounding in telecommunication networks).

**Material:** Copper Alloy.

**Finish:** Tin plated Application Tool: Water pump pliers.

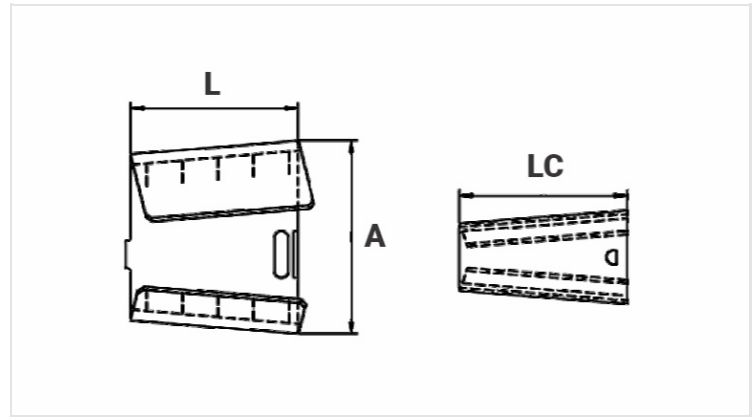

**Datasheet**

**Conductor**

AWG/MCM 4 - 2

mm<sup>2</sup> 25 - 35

**Ground Rod Diameter**

1/2" (12,7mm)

**Dimensions**

L 31,7

A 40,5

LC 31,7

**Package**

Qty / Emb 50

Peso Unit. (g) 58,00