

CCA - WEDGE TYPE CONNECTOR FOR GROUNDING

CCA-58-35

Description

Purpose: Connection between ground rod to cable. Suitable for COPPERSTEEL or copper cables.

Characteristics: Spring system connection (permanent tightening). High resistance to corrosion. Easy application. Supplied with antioxidant compound INTELTRON-Cu.

Application: Grounding systems in general (power distribution systems, grounding grids, residential, building and industrial grounding), grounding in telecommunication networks).

Material: Copper Alloy.

Finish: Tin plated Application Tool: Water pump pliers.

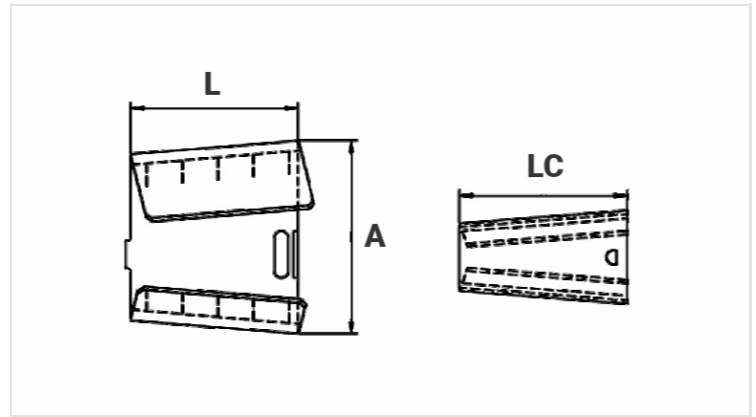

Datasheet

Conductor

AWG/MCM 8 - 2

mm² 10 - 35

Ground Rod Diameter

5/8" (14,3mm)

Dimensions

L 31,7

A 42,0

LC 31,7

Package

Qty / Emb 50

Unit Weight (g) 58,00