

PH - DRIVING STUD

PH-58

Description

Purpose: Used for driving sectional copperbonded ground rods (IHP).

Characteristics: High impact and shock resistance.

Application: Grounding of sectional copperbonded ground rod. The driving stud is attached to the coupling to prevent damage to the threads of the stud during ground rod driving.

Material: High mechanical resistance steel.

Finish: Black oxidation.

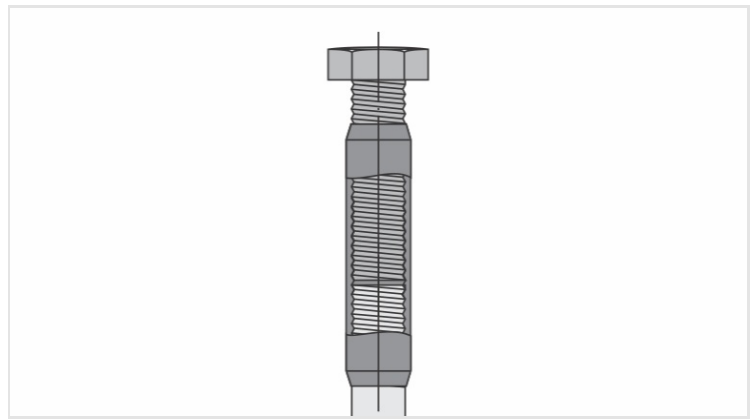
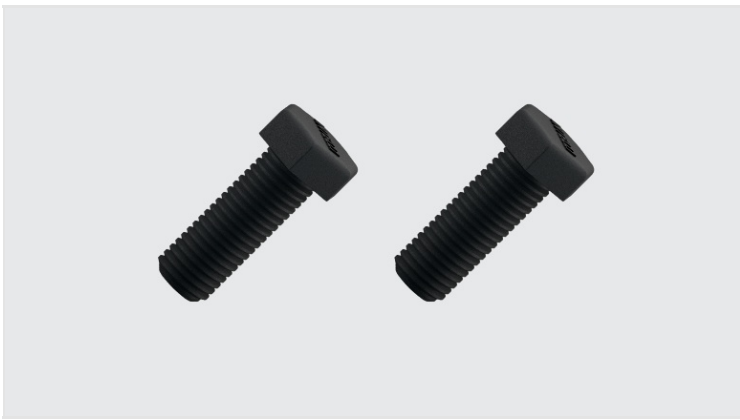

Datasheet

Threaded Couplings LEH

LEH-58-R

Thread / Length of Screw

5/8" UNC x 2"

Package

Qtd / Emb

50

Peso Unit. (g)

98,00