

LEH - THREADED COUPLINGS FOR SECTIONAL GROUND ROD

LEH-34-R

Description

Purpose: Connecting two ground rods (IHP) to extend total length.

Characteristics: High resistance to corrosion. Ensures a good connection between the sectional copperbonded ground rods.

Application: Grounding systems in general.

Material: Copper alloy.

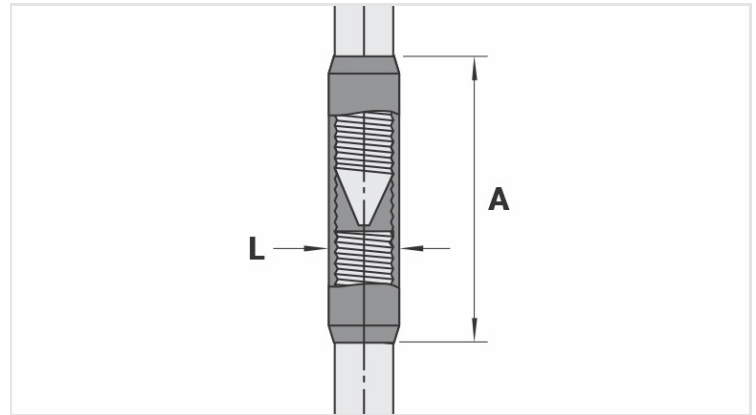

Datasheet

Thread / Ground Rod (Inches)	3/4"
Dimensions (mm)	
L	25,4
A	70,0
Package	
Qtd / Emb	20
Peso Unit. (g)	140,00