

TM - COPPER COMPRESSION TERMINAL (ONE HOLE / SHORT BARREL)

TM-185-10

Description

Purpose: Termination of copper conductors.

Characteristics: High electrical conductivity and corrosion resistance. Pad with several hole diameter options and optimum electrical contact.

Applications: Electrical panels, circuit breaker connections, motors, machines, busbars, electrical distribution boards, among others.

Material: Electrolytic copper.

Finish: Tin plated.

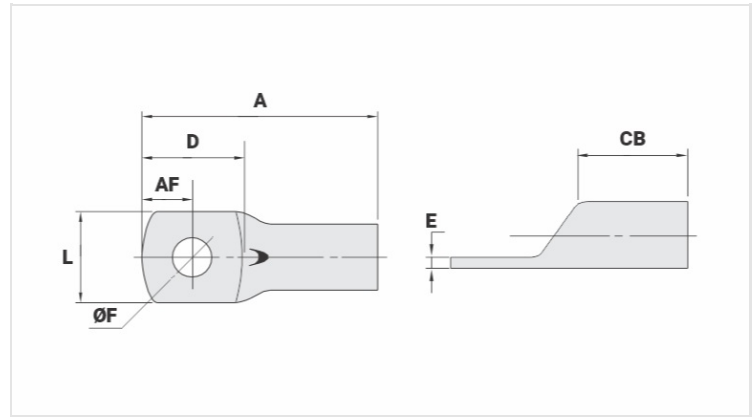

Datasheet

Conductors - Cross Section (mm²) 185

Dimensions (mm)

Diâmetro do Furo (mm)	10,5
Parafuso*	
Pol.	1/2
Métrico	M12
L	32,4
A	68,5
CB	26,0
AF	13,5
D	29,5
E	3,8

Current (A) 661

Application Tool

Alicate Mecânico	
Modelo	-
Matriz (AT-60)	-
Alicate Hidráulico (AY-96 / CY-96)	
Matriz Circunf.	IU-31
Matriz Hexagonal	H-31

Package

Qtd / Emb

30

Peso Unit. (g)

68,10