

TM-L - COPPER COMPRESSION TERMINAL (ONE HOLE / LONG BARREL)

TM-16-L-8

Description

Purpose: Termination of copper conductors.

Characteristics: High electrical conductivity and corrosion resistance. Pad with several hole diameter options and optimum electrical contact.

Applications: Electrical panels, circuit breaker connections, motors, machines, busbars, electrical distribution boards, among others.

Material: Electrolytic copper.

Finish: Tin plated.

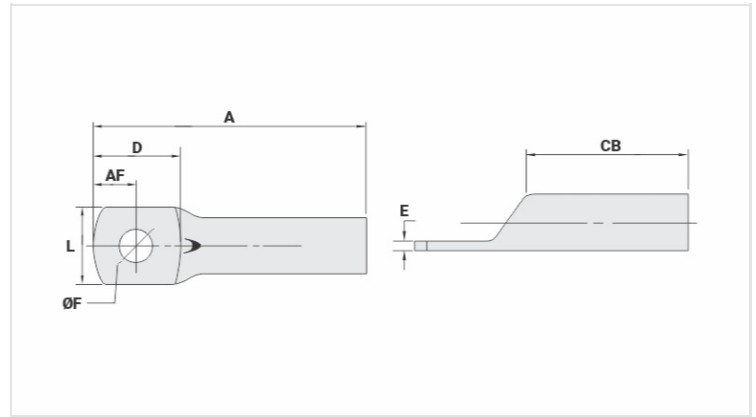

Datasheet

Conductors - Cross Section (mm²) 16

Dimensions (mm)

Diâmetro do Furo (mm)	8,5
Parafuso*	
Pol.	1/4
Métrico	M6
L	11,3
A	37,5
CB	20,0
AF	6,0
D	13,5
E	2,0

Current (A) 137

Application Tool

Alicate Mecânico	
Modelo	AT-60/68
Matriz (AT-60)	IW-5
Alicate Hidráulico (AY-96 / CY-96)	
Matriz Circunf.	IU-5
Matriz Hexagonal	H-5

Package

Qtd / Emb

100

Peso Unit. (g)

6,50