

TM-L - COPPER COMPRESSION TERMINAL (ONE HOLE / LONG BARREL)

TM-95-L

Description

Purpose: Termination of copper conductors.

Characteristics: High electrical conductivity and corrosion resistance. Pad with several hole diameter options and optimum electrical contact.

Applications: Electrical panels, circuit breaker connections, motors, machines, busbars, electrical distribution boards, among others.

Material: Electrolytic copper.

Finish: Tin plated.

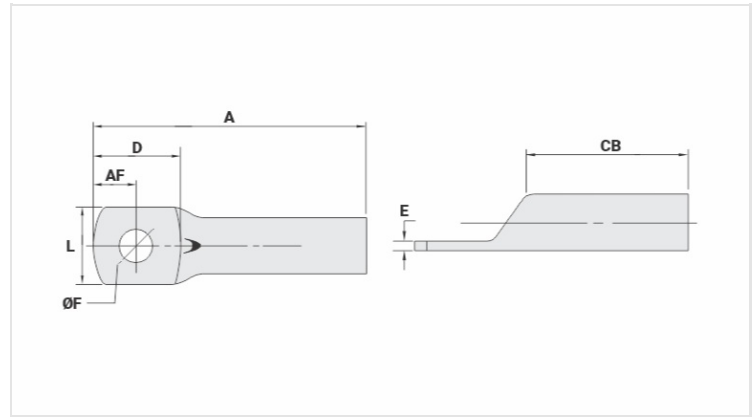

Datasheet

Conductors - Cross Section (mm²) 95

Dimensions (mm)

Diâmetro do Furo (mm)	13,8
Parafuso*	
Pol.	1/2
Métrico	M12
L	24,0
A	60,0
CB	28,5
AF	10,0
D	22,0
E	3,0

Current (A) 430

Application Tool

Alicate Mecânico	
Modelo	AT-60/68
Matriz (AT-60)	IW-27
Alicate Hidráulico (AY-96 / CY-96)	
Matriz Circunf.	IU-27
Matriz Hexagonal	H-27

Package

Qtd / Emb

50

Peso Unit. (g)

32,10