

TM-2 - COPPER COMPRESSION TERMINAL (TWO HOLES / SHORT BARREL)

TM-70-2

Description

Purpose: Termination of copper conductors.

Characteristics: High electrical conductivity and corrosion resistance. Pad with several hole diameter options and optimum electrical contact.

Applications: Electrical panels, circuit breaker connections, motors, machines, busbars, electrical distribution boards, among others.

Material: Electrolytic copper.

Finish: Tin plated.

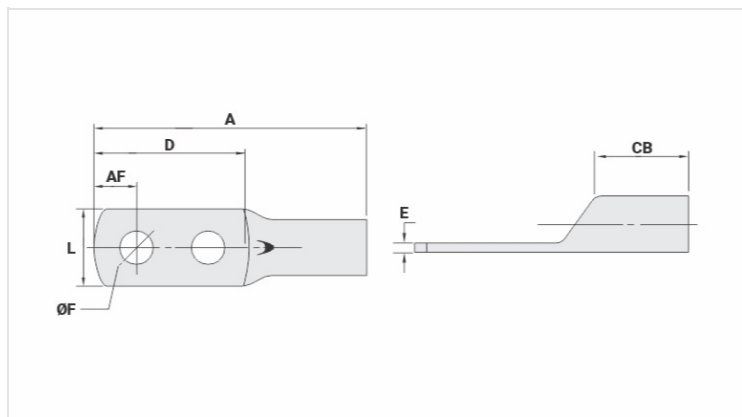

Datasheet

Conductors - Cross Section (mm²) 70

Dimensions (mm)

Diâmetro do Furo (mm) 13,8

Parafuso*

Pol. 1/2

Métrico M12

L 20,3

A 91,0

CB 16,5

AF 10,0

D 66,4

E 3,0

Current (A) 353

Application Tool

Alicate Mecânico

Modelo AT-60/68

Matriz (AT-60) IW-26

Alicate Hidráulico (AY-96 / CY-96)

Matriz Circunf. IU-26

Matriz Hexagonal H-26

Package

Qtd / Emb

20

Peso Unit. (g)

40,00