

TM-2 - COPPER COMPRESSION TERMINAL (TWO HOLES / SHORT BARREL)

TM-400-2

Description

Purpose: Termination of copper conductors.

Characteristics: High electrical conductivity and corrosion resistance. Pad with several hole diameter options and optimum electrical contact.

Applications: Electrical panels, circuit breaker connections, motors, machines, busbars, electrical distribution boards, among others.

Material: Electrolytic copper.

Finish: Tin plated.

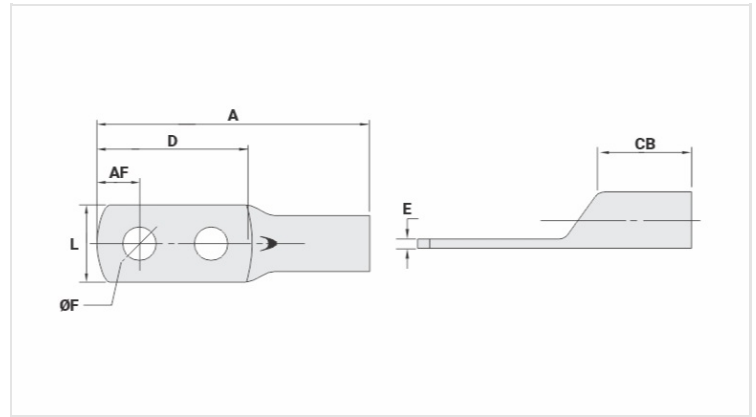

Datasheet

Conductors - Cross Section (mm²) 400

Dimensions (mm)

Diâmetro do Furo (mm)	13,8
Parafuso*	
Pol.	1/2
Métrico	M12
L	46,8
A	147,0
CB	38,0
AF	19,0
D	86,4
E	5,3

Current (A) 1085

Application Tool

Alicate Mecânico	
Modelo	-
Matriz (AT-60)	-
Alicate Hidráulico (AY-96 / CY-96)	
Matriz Circunf.	IU-40
Matriz Hexagonal	H-40

Package

Qty / Emb

15

Peso Unit. (g)

302,00