

TM-2L - COPPER COMPRESSION TERMINAL (TWO HOLES / LONG BARREL)

TM-10-2L

Description

Purpose: Termination of copper conductors.

Characteristics: High electrical conductivity and corrosion resistance. Pad with several hole diameter options and optimum electrical contact.

Applications: Electrical panels, circuit breaker connections, motors, machines, busbars, electrical distribution boards, among others.

Material: Electrolytic copper.

Finish: Tin plated.

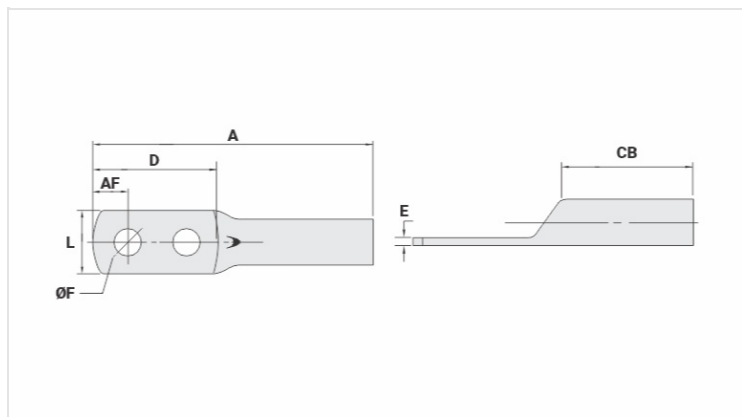

Datasheet

Conductors - Cross Section (mm²) 10

Dimensions (mm)

Diâmetro do Furo (mm) 5,2

Parafuso*

Pol. 3/16

Métrico M5

L 8,6

A 45,0

CB 16,0

AF 5,0

D 25,0

E 1,5

Current (A) 101

Application Tool

Alicate Mecânico

Modelo AT-60/68

Matriz (AT-60) IW-8

Alicate Hidráulico (AY-96 / CY-96)

Matriz Circunf. IU-8

Matriz Hexagonal H-8

Package

Qtd / Emb

50

Peso Unit. (g)

4,40