

TF - COPPER TERMINAL FOR FLEXIBLE CONDUCTORS (ONE HOLE / SHORT BARREL)

TF-10

Description

Purpose: Termination of copper conductors.

Characteristics: High electrical conductivity and corrosion resistance. Pad with several hole diameter options and optimum electrical contact. Expanded shape barrel for easy insertion of flexible conductors.

Applications: Electrical panels, circuit breaker connections, motors, machines, busbars, electrical distribution boards, among others.

Material: Electrolytic copper.

Finish: Tin Plated.

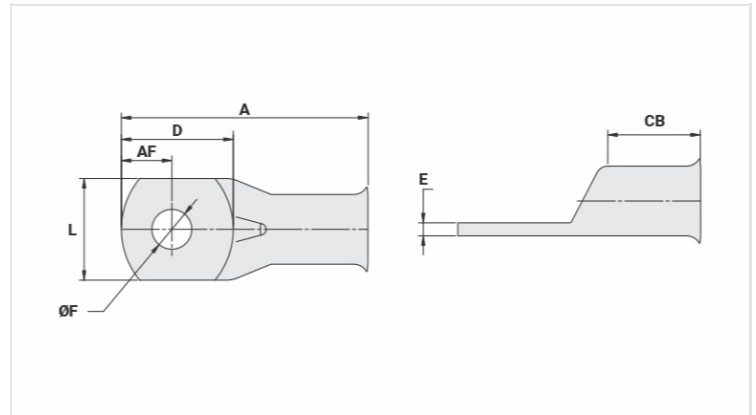

Datasheet

Conductors - Cross Section (mm²) 10

Dimensions (mm)

Diâmetro do Furo (mm)	5,2
Parafuso*	
Pol.	3/16
Métrico	M5
L	8,5
A	22,5
CB	7,5
AF	5,0
D	11,0
E	1,5

Current (A) 101

Application Tool

Alicate Mecânico	
Modelo	AT-60/68
Matriz (AT-60)	IW-8
Alicate Hidráulico (AY-96 / CY-96)	
Matriz Circunf.	IU-8
Matriz Hexagonal	H-8

Package

Qtd / Emb

100

Peso Unit. (g)

2,20