

TF - COPPER TERMINAL FOR FLEXIBLE CONDUCTORS (ONE HOLE / SHORT BARREL)

TF-16-6

Description

Purpose: Termination of copper conductors.

Characteristics: High electrical conductivity and corrosion resistance. Pad with several hole diameter options and optimum electrical contact. Expanded shape barrel for easy insertion of flexible conductors.

Applications: Electrical panels, circuit breaker connections, motors, machines, busbars, electrical distribution boards, among others.

Material: Electrolytic copper.

Finish: Tin Plated.

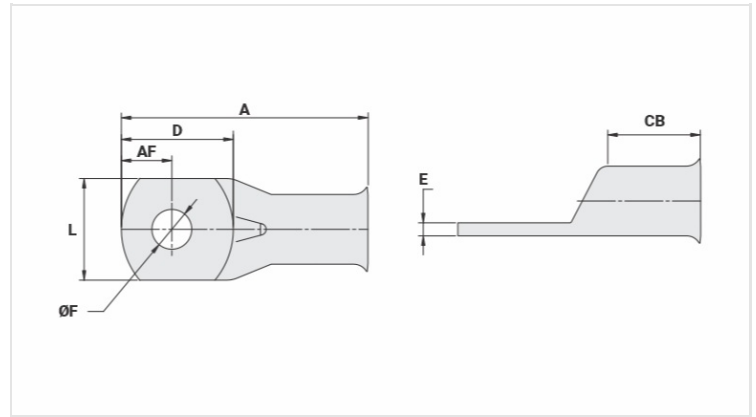

Datasheet

Conductors - Cross Section (mm²) 16

Dimensions (mm)

Diâmetro do Furo (mm)	6,5
Parafuso*	
Pol.	3/16
Métrico	M5
L	11,3
A	28,0
CB	9,5
AF	6,0
D	13,5
E	2,0

Current (A) 137

Application Tool

Alicate Mecânico	
Modelo	AT-60/68
Matriz (AT-60)	IW-5
Alicate Hidráulico (AY-96 / CY-96)	
Matriz Circunf.	IU-5
Matriz Hexagonal	H-5

Package

Qtd / Emb

100

Peso Unit. (g)

4,8