

**TF - COPPER TERMINAL FOR FLEXIBLE CONDUCTORS (ONE HOLE / SHORT BARREL)**

TF-25

**Description**

**Purpose:** Termination of copper conductors.

**Characteristics:** High electrical conductivity and corrosion resistance. Pad with several hole diameter options and optimum electrical contact. Expanded shape barrel for easy insertion of flexible conductors.

**Applications:** Electrical panels, circuit breaker connections, motors, machines, busbars, electrical distribution boards, among others.

**Material:** Electrolytic copper.

**Finish:** Tin Plated.

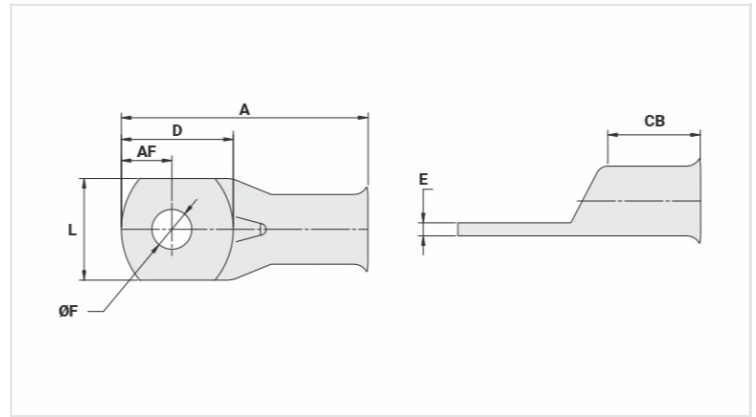

**Datasheet**

**Conductors - Cross Section (mm<sup>2</sup>)**

25

**Dimensions (mm)**

Diâmetro do Furo (mm)

6,5

Parafuso\*

Pol.

1/4

Métrico

M6

L

12,9

A

31,5

CB

10,5

AF

6,0

D

15,5

E

2,2

**Current (A)**

182

**Application Tool**

Alicate Mecânico

Modelo

AT-60/68

Matriz (AT-60)

IW-4

Alicate Hidráulico (AY-96 / CY-96)

Matriz Circunf.

IU-4

Matriz Hexagonal

H-4

**Package**

Qtd / Emb

100

Peso Unit. (g)

7,20