

**TF - COPPER TERMINAL FOR FLEXIBLE CONDUCTORS (ONE HOLE / SHORT BARREL)**

TF-35-10

**Description**

**Purpose:** Termination of copper conductors.

**Characteristics:** High electrical conductivity and corrosion resistance. Pad with several hole diameter options and optimum electrical contact. Expanded shape barrel for easy insertion of flexible conductors.

**Applications:** Electrical panels, circuit breaker connections, motors, machines, busbars, electrical distribution boards, among others.

**Material:** Electrolytic copper.

**Finish:** Tin Plated.

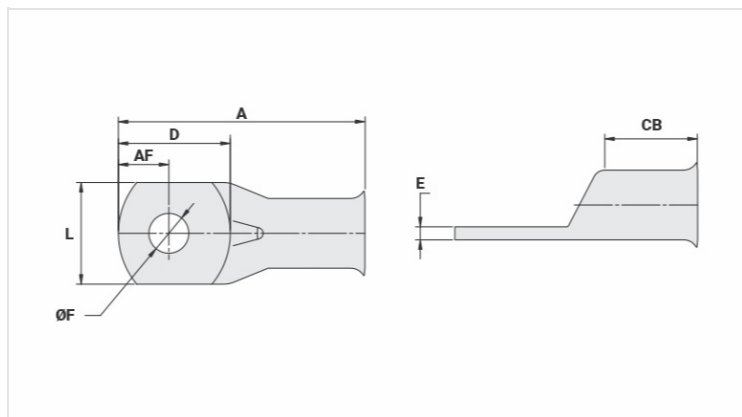

**Datasheet**

**Conductors - Cross Section (mm<sup>2</sup>)** 35

**Dimensions (mm)**

Diâmetro do Furo (mm)	10,5
Parafuso*	
Pol.	5/16
Métrico	M8
L	15,0
A	36,0
CB	11,5
AF	8,0
D	17,5
E	2,4

**Current (A)** 226

**Application Tool**

Alicate Mecânico	
Modelo	AT-60/68
Matriz (AT-60)	IW-4
Alicate Hidráulico (AY-96 / CY-96)	
Matriz Circunf.	IU-2
Matriz Hexagonal	H-2

**Package**

Qtd / Emb

100

Peso Unit. (g)

8,90