

TF - COPPER TERMINAL FOR FLEXIBLE CONDUCTORS (ONE HOLE / SHORT BARREL)

TF-70-13

Description

Purpose: Termination of copper conductors.

Characteristics: High electrical conductivity and corrosion resistance. Pad with several hole diameter options and optimum electrical contact. Expanded shape barrel for easy insertion of flexible conductors.

Applications: Electrical panels, circuit breaker connections, motors, machines, busbars, electrical distribution boards, among others.

Material: Electrolytic copper.

Finish: Tin Plated.

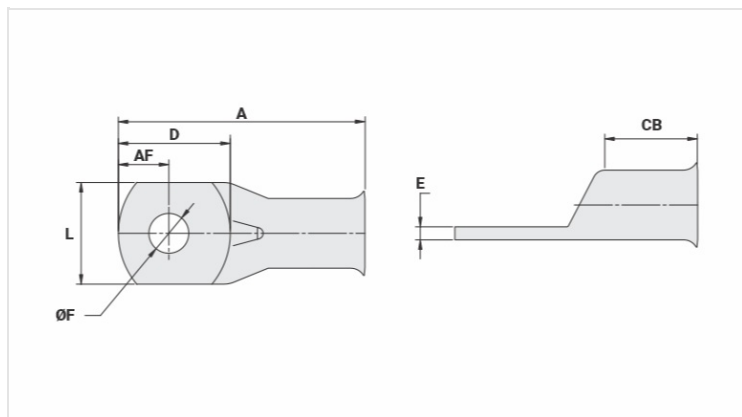

Datasheet

Conductors - Cross Section (mm²) 70

Dimensions (mm)

Diâmetro do Furo (mm)	13,8
Parafuso*	
Pol.	3/8
Métrico	M10
L	20,3
A	45,5
CB	16,0
AF	10,0
D	22,0
E	3,0

Current (A) 353

Application Tool

Alicate Mecânico	
Modelo	AT-60/68
Matriz (AT-60)	IW-26
Alicate Hidráulico (AY-96 / CY-96)	
Matriz Circunf.	IU-26
Matriz Hexagonal	H-26

Package

Qtd / Emb

50

Peso Unit. (g)

20,00