

TF - COPPER TERMINAL FOR FLEXIBLE CONDUCTORS (ONE HOLE / SHORT BARREL)

TF-150-10

Description

Purpose: Termination of copper conductors.

Characteristics: High electrical conductivity and corrosion resistance. Pad with several hole diameter options and optimum electrical contact. Expanded shape barrel for easy insertion of flexible conductors.

Applications: Electrical panels, circuit breaker connections, motors, machines, busbars, electrical distribution boards, among others.

Material: Electrolytic copper.

Finish: Tin Plated.

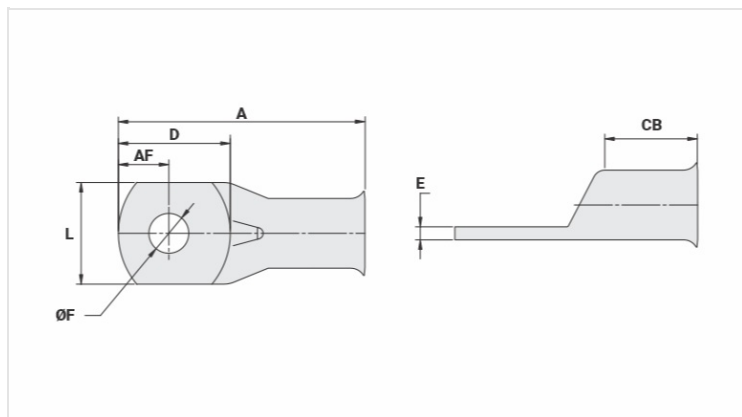

Datasheet

Conductors - Cross Section (mm²) 150

Dimensions (mm)

Diâmetro do Furo (mm)	10,5
Parafuso*	
Pol.	1/2
Métrico	M12
L	30,0
A	66,0
CB	24,0
AF	13,0
D	29,5
E	3,6

Current (A) 577

Application Tool

Alicate Mecânico	
Modelo	-
Matriz (AT-60)	-
Alicate Hidráulico (AY-96 / CY-96)	
Matriz Circunf.	IU-30
Matriz Hexagonal	H-30

Package

Qty / Emb

30

Peso Unit. (g)

58,60