

**TF - COPPER TERMINAL FOR FLEXIBLE CONDUCTORS (ONE HOLE / SHORT BARREL)**

TF-240

**Description**

**Purpose:** Termination of copper conductors.

**Characteristics:** High electrical conductivity and corrosion resistance. Pad with several hole diameter options and optimum electrical contact. Expanded shape barrel for easy insertion of flexible conductors.

**Applications:** Electrical panels, circuit breaker connections, motors, machines, busbars, electrical distribution boards, among others.

**Material:** Electrolytic copper.

**Finish:** Tin Plated.

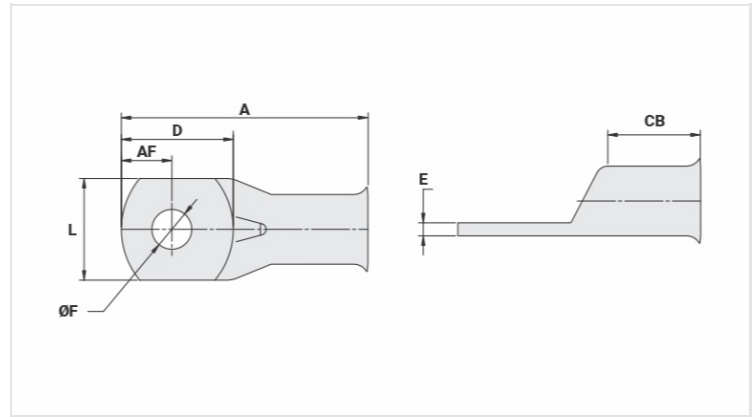

**Datasheet**

**Conductors - Cross Section (mm<sup>2</sup>)** 240

**Dimensions (mm)**

Diâmetro do Furo (mm)	13,8
Parafuso*	
Pol.	1/2
Métrico	M12
L	38,0
A	79,0
CB	28,0
AF	17,0
D	35,0
E	4,8

**Current (A)** 781

**Application Tool**

Alicate Mecânico	
Modelo	-
Matriz (AT-60)	-
Alicate Hidráulico (AY-96 / CY-96)	
Matriz Circunf.	IU-34
Matriz Hexagonal	H-34

**Package**

Qtd / Emb

20

Peso Unit. (g)

116,00