

**TF - COPPER TERMINAL FOR FLEXIBLE CONDUCTORS (ONE HOLE / SHORT BARREL)**

TF-300

**Description**

**Purpose:** Termination of copper conductors.

**Characteristics:** High electrical conductivity and corrosion resistance. Pad with several hole diameter options and optimum electrical contact. Expanded shape barrel for easy insertion of flexible conductors.

**Applications:** Electrical panels, circuit breaker connections, motors, machines, busbars, electrical distribution boards, among others.

**Material:** Electrolytic copper.

**Finish:** Tin Plated.

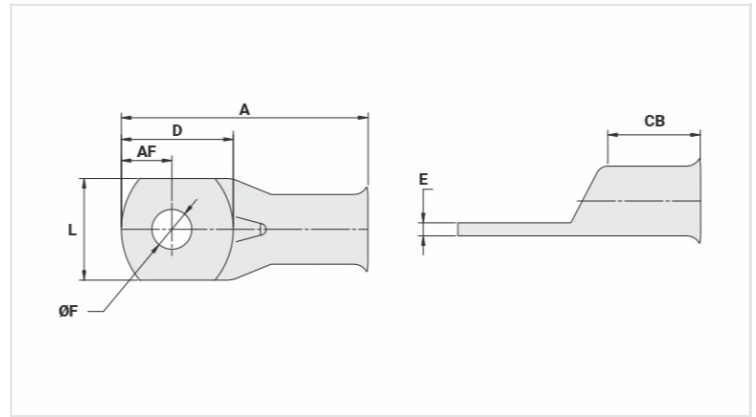

**Datasheet**

**Conductors - Cross Section (mm<sup>2</sup>)** 300

**Dimensions (mm)**

Diâmetro do Furo (mm)	17,5
Parafuso*	
Pol.	5/8
Métrico	M16
L	41,5
A	89,5
CB	33,0
AF	19,0
D	40,0
E	5,0

**Current (A)** 902

**Application Tool**

Alicate Mecânico	
Modelo	-
Matriz (AT-60)	-
Alicate Hidráulico (AY-96 / CY-96)	
Matriz Circunf.	IU-36
Matriz Hexagonal	H-36

**Package**

Qtd / Emb

15

Peso Unit. (g)

144,50