

**TF-L - COPPER TERMINAL FOR FLEXIBLE CONDUCTORS (ONE HOLE / LONG BARREL)**

TF-10-L-6

**Description**

**Purpose:** Termination of copper conductors.

**Characteristics:** High electrical conductivity and corrosion resistance. Pad with several hole diameter options and optimum electrical contact. Expanded shape barrel for easy insertion of flexible conductors.

**Applications:** Electrical panels, circuit breaker connections, motors, machines, busbars, electrical distribution boards, among others.

**Material:** Electrolytic copper.

**Finish:** Tin Plated.

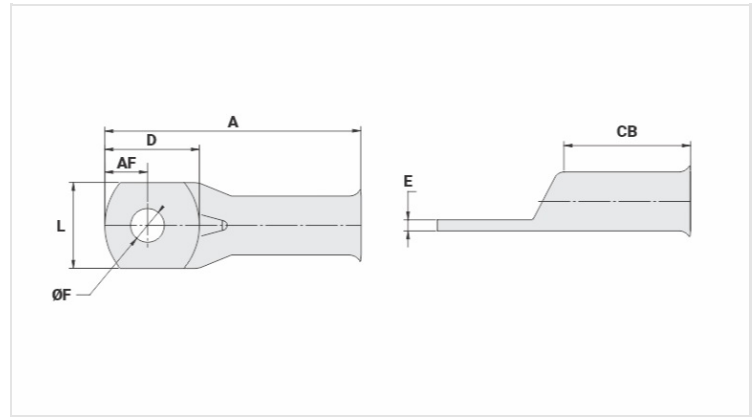

**Datasheet**

**Conductors - Cross Section (mm<sup>2</sup>)** 10

**Dimensions (mm)**

Diâmetro do Furo (mm)	6,5
Parafuso*	
Pol.	3/16
Métrico	M5
L	8,6
A	31,0
CB	16,0
AF	5,0
D	11,0
E	1,5

**Current (A)** 101

**Application Tool**

Alicate Mecânico	
Modelo	AT-60/68
Matriz (AT-60)	IW-8
Alicate Hidráulico (AY-96 / CY-96)	
Matriz Circunf.	IU-8
Matriz Hexagonal	H-8

**Package**

Qtd / Emb

100

Peso Unit. (g)

3,00