

**TF-L - COPPER TERMINAL FOR FLEXIBLE CONDUCTORS (ONE HOLE / LONG BARREL)**

TF-35-L-10

**Description**

**Purpose:** Termination of copper conductors.

**Characteristics:** High electrical conductivity and corrosion resistance. Pad with several hole diameter options and optimum electrical contact. Expanded shape barrel for easy insertion of flexible conductors.

**Applications:** Electrical panels, circuit breaker connections, motors, machines, busbars, electrical distribution boards, among others.

**Material:** Electrolytic copper.

**Finish:** Tin Plated.

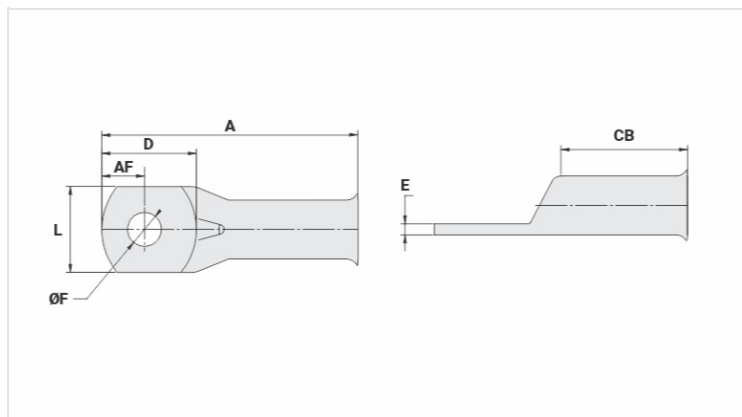

**Datasheet**

**Conductors - Cross Section (mm<sup>2</sup>)** 35

**Dimensions (mm)**

|                       |      |
|-----------------------|------|
| Diâmetro do Furo (mm) | 10,5 |
| Parafuso*             |      |
| Pol.                  | 5/16 |
| Métrico               | M8   |
| L                     | 15,0 |
| A                     | 46,5 |
| CB                    | 22,0 |
| AF                    | 8,0  |
| D                     | 17,5 |
| E                     | 2,4  |

**Current (A)** 226

**Application Tool**

|                                    |          |
|------------------------------------|----------|
| Alicate Mecânico                   |          |
| Modelo                             | AT-60/68 |
| Matriz (AT-60)                     | IW-4     |
| Alicate Hidráulico (AY-96 / CY-96) |          |
| Matriz Circunf.                    | IU-2     |
| Matriz Hexagonal                   | H-2      |

**Package**

Qtd / Emb

100

Peso Unit. (g)

12,10