

TF-L - COPPER TERMINAL FOR FLEXIBLE CONDUCTORS (ONE HOLE / LONG BARREL)

TF-50-L-6

Description

Purpose: Termination of copper conductors.

Characteristics: High electrical conductivity and corrosion resistance. Pad with several hole diameter options and optimum electrical contact. Expanded shape barrel for easy insertion of flexible conductors.

Applications: Electrical panels, circuit breaker connections, motors, machines, busbars, electrical distribution boards, among others.

Material: Electrolytic copper.

Finish: Tin Plated.

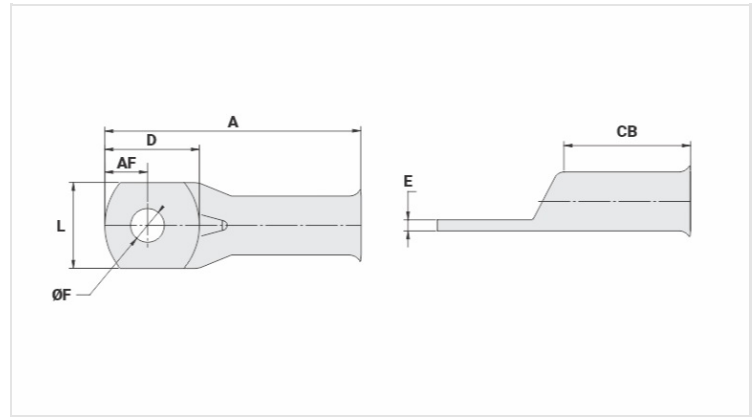

Datasheet

Conductors - Cross Section (mm²) 50

Dimensions (mm)

Diâmetro do Furo (mm)	6,5
Parafuso*	
Pol.	5/16
Métrico	M8
L	18,0
A	54,5
CB	27,0
AF	9,0
D	19,5
E	2,7

Current (A) 275

Application Tool

Alicate Mecânico	
Modelo	AT-60/68
Matriz (AT-60)	IW-1
Alicate Hidráulico (AY-96 / CY-96)	
Matriz Circunf.	IU-25**
Matriz Hexagonal	H-25

Package

Qtd / Emb

50

Peso Unit. (g)

21,30