

TF-L - COPPER TERMINAL FOR FLEXIBLE CONDUCTORS (ONE HOLE / LONG BARREL)

TF-150-L

Description

Purpose: Termination of copper conductors.

Characteristics: High electrical conductivity and corrosion resistance. Pad with several hole diameter options and optimum electrical contact. Expanded shape barrel for easy insertion of flexible conductors.

Applications: Electrical panels, circuit breaker connections, motors, machines, busbars, electrical distribution boards, among others.

Material: Electrolytic copper.

Finish: Tin Plated.

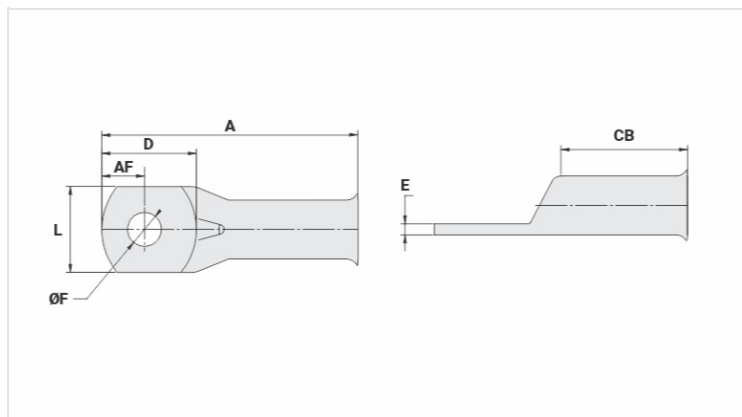

Datasheet

Conductors - Cross Section (mm²) 150

Dimensions (mm)

Diâmetro do Furo (mm) 13,8

Parafuso*

Pol. 1/2

Métrico M12

L 30,0

A 79,5

CB 38,0

AF 13,0

D 29,5

E 3,6

Current (A) 577

Application Tool

Alicate Mecânico

Modelo -

Matriz (AT-60) -

Alicate Hidráulico (AY-96 / CY-96)

Matriz Circunf. IU-30

Matriz Hexagonal H-30

Package

Qtd / Emb

25

Peso Unit. (g)

68,50