

TF-L - COPPER TERMINAL FOR FLEXIBLE CONDUCTORS (ONE HOLE / LONG BARREL)

TF-500-L

Description

Purpose: Termination of copper conductors.

Characteristics: High electrical conductivity and corrosion resistance. Pad with several hole diameter options and optimum electrical contact. Expanded shape barrel for easy insertion of flexible conductors.

Applications: Electrical panels, circuit breaker connections, motors, machines, busbars, electrical distribution boards, among others.

Material: Electrolytic copper.

Finish: Tin Plated.

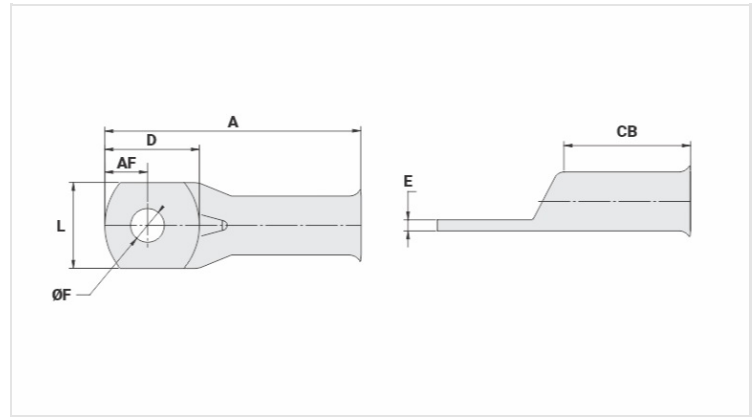

Datasheet

Conductors - Cross Section (mm²) 500

Dimensions (mm)

Diâmetro do Furo (mm)	13,8
Parafuso*	
Pol.	1/2
Métrico	M12
L	60,0
A	129,0
CB	66,0
AF	19,0
D	42,0
E	5,1

Current (A) 1253

Application Tool

Alicate Mecânico	
Modelo	-
Matriz (AT-60)	-
Alicate Hidráulico (AY-96 / CY-96)	
Matriz Circunf.	IU-44
Matriz Hexagonal	H-44

Package

Qtd / Emb

8

Peso Unit. (g)

295,00