

**TF-2 - COPPER TERMINAL FOR FLEXIBLE CONDUCTORS (TWO HOLES / SHORT BARREL)**

TF-300-2

**Description**

**Purpose:** Termination of copper conductors.

**Characteristics:** High electrical conductivity and corrosion resistance. Pad with several hole diameter options and optimum electrical contact. Expanded shape barrel for easy insertion of flexible conductors.

**Applications:** Electrical panels, circuit breaker connections, motors, machines, busbars, electrical distribution boards, among others.

**Material:** Electrolytic copper.

**Finish:** Tin Plated.

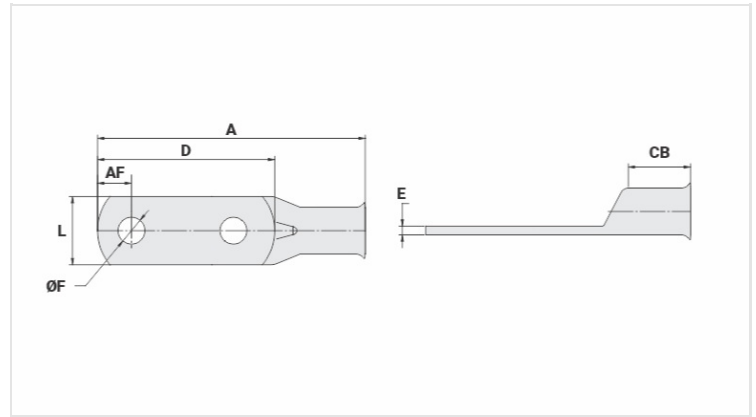

**Datasheet**

**Conductors - Cross Section (mm<sup>2</sup>)** 300

**Dimensions (mm)**

Diâmetro do Furo (mm)	13,8
Parafuso*	
Pol.	1/2
Métrico	M12
L	41,5
A	135,4
CB	31,5
AF	19,0
D	84,4
E	5,0

**Current (A)** 902

**Application Tool**

Alicate Mecânico	
Modelo	-
Matriz (AT-60)	-
Alicate Hidráulico (AY-96 / CY-96)	
Matriz Circunf.	IU-36
Matriz Hexagonal	H-36

**Package**

Qty / Emb

20

Peso Unit. (g)

226,00