

TAL - EXTRUDED ALUMINUM TERMINAL (ONE HOLE)

TAL-32

Description

Purpose: Cable to busbar termination for CA or CAA aluminum cables.

Characteristics: Compression connection. High electrical conductivity and resistance to corrosion.

Application: Power distribution lines.

Material: Extruded aluminum. Supplied with antioxiide compound INTELTROX.

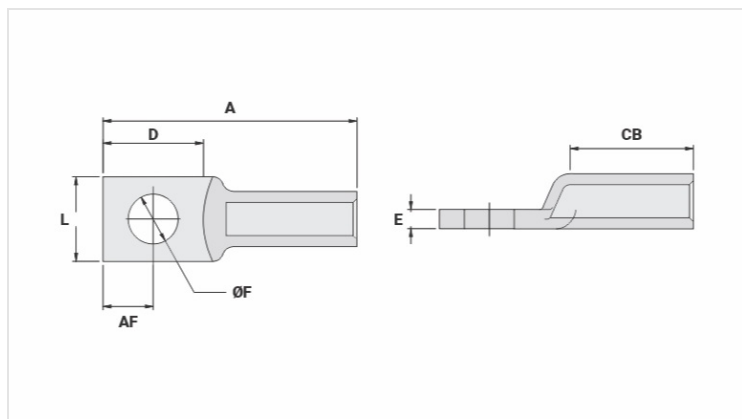

Datasheet

Conductors

CA Compacto (mm ²)	25
AWG/MCM	
CA	4
CAA	4

Dimensions

Diâmetro do Furo (mm)	13,0
Parafuso	
Pol.	1/2
Métrico	M12
L	22,0
A	66,0
CB	32,0
D	26,0
E	5,0
AF	13,0

Application Tool

Alicate Mecânico (AT-60 4t)	
Matriz	IW-239
Compressões	2
Alicate Hidráulico (AY-96 / CY-96)	
Matriz	IU-239
Compressões	1

Package

Qty / Emb

50

Peso Unit. (g)

19,50