

TAL - EXTRUDED ALUMINUM TERMINAL (ONE HOLE)

TAL-58

Description

Purpose: Cable to busbar termination for CA or CAA aluminum cables.

Characteristics: Compression connection. High electrical conductivity and resistance to corrosion.

Application: Power distribution lines.

Material: Extruded aluminum. Supplied with antioxiide compound INTELTROX.

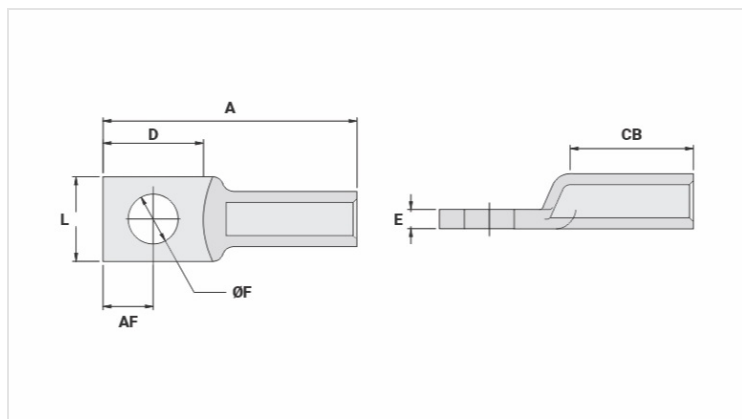

Datasheet

Conductors

CA Compacto (mm ²)	95
AWG/MCM	
CA	3/0
CAA	-

Dimensions

Diâmetro do Furo (mm)	14,0
Parafuso	
Pol.	1/2
Métrico	M12
L	27,0
A	92,0
CB	47,0
D	33,0
E	6,8
AF	16,0

Application Tool

Alicate Mecânico (AT-60 4t)	
Matriz	IW-247
Compressões	4
Alicate Hidráulico (AY-96 / CY-96)	
Matriz	IU-247
Compressões	2

Package

Qty / Emb

40

Peso Unit. (g)

39,30