

TAL-2 - EXTRUDED ALUMINUM TERMINAL (TWO HOLES)

TAL-38-2

Description

Purpose: Cable to busbar termination for CA or CAA aluminum cables.

Characteristics: Compression connection. High electrical conductivity and resistance to corrosion.

Application: Power distribution lines.

Material: Extruded aluminum. Supplied with antioxidant compound INTELTROX.

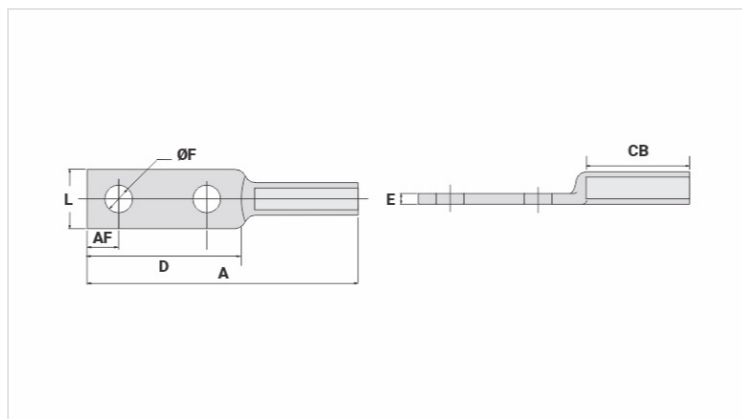

Datasheet

Conductors

| | |
|--------------------------------|----|
| CA Compacto (mm ²) | 35 |
| AWG/MCM | |
| CA | 2 |
| CAA | 2 |

Dimensions

| | |
|-----------------------|-------|
| Diâmetro do Furo (mm) | 14,0 |
| Parafuso | |
| Pol. | 1/2 |
| Métrico | M12 |
| L | 22,0 |
| A | 138,0 |
| CB | 54,0 |
| D | 76,0 |
| E | 5,0 |
| AF | 16,0 |

Application Tool

| | |
|------------------------------------|--------|
| Alicate Mecânico (AT-60 4t) | |
| Matriz | IW-239 |
| Compressões | 4 |
| Alicate Hidráulico (AY-96 / CY-96) | |
| Matriz | IU-239 |
| Compressões | 2 |

Package

Qty / Emb

100

Peso Unit. (g)

34,00