

TAL-2 - EXTRUDED ALUMINUM TERMINAL (TWO HOLES)

TAL-72-2

Description

Purpose: Cable to busbar termination for CA or CAA aluminum cables.

Characteristics: Compression connection. High electrical conductivity and resistance to corrosion.

Application: Power distribution lines.

Material: Extruded aluminum. Supplied with antioxidant compound INTELTROX.

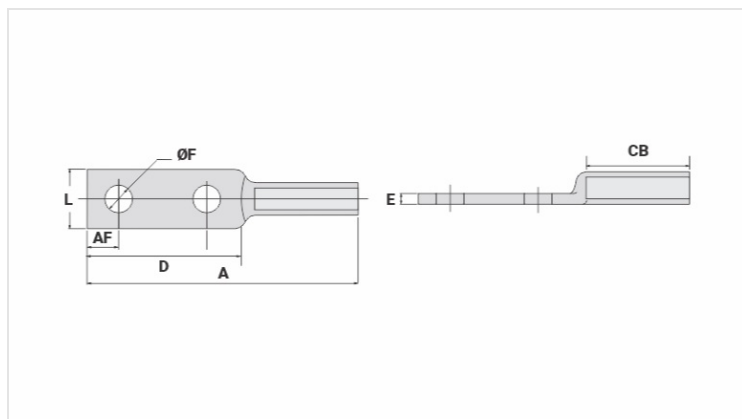

Datasheet

Conductors

CA Compacto (mm ²)	185
AWG/MCM	
CA	336,4
CAA	-

Dimensions

Diâmetro do Furo (mm)	14,0
Parafuso	
Pol.	1/2
Métrico	M12
L	37,0
A	177,0
CB	72,0
D	78,0
E	9,0
AF	16,0

Application Tool

Alicate Mecânico (AT-60 4t)	
Matriz	-
Compressões	-
Alicate Hidráulico (AY-96 / CY-96)	
Matriz	IU-321
Compressões	4

Package

Qty / Emb

20

Peso Unit. (g)

138,00