

**TBTA - BIMETALLIC COMPRESSION TERMINAL**

TBTA-35-13

**Description**

**Purpose:** Bimetallic cable to busbar termination (aluminum or ALUMOSTEEL cable to copper busbar).

**Characteristics:** Compression connection. Its construction (copper pad and aluminum barrel) prevents the formation of galvanic corrosion. Pad with one hole.

**Applications:** Power distribution lines.

**Material:** Electrolytic copper pad and extruded aluminum barrel. Supplied with antioxidant compound INTELTROX.

**Note:** For installation in regions of aggressive environments, it is recommended to use thermoset insulation or self-fusing tape in the connection.

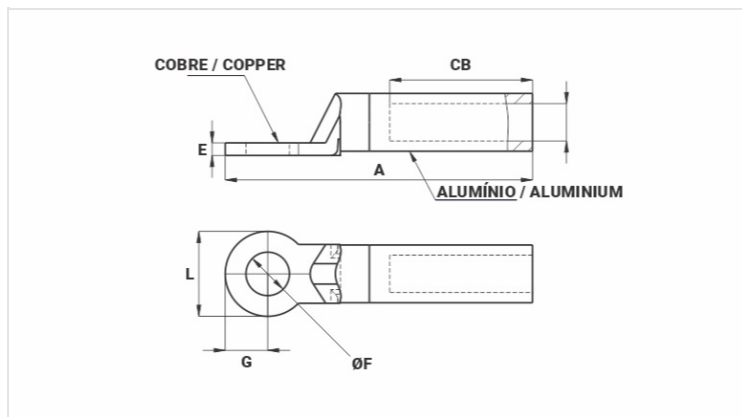

**Datasheet**

**AAC Conductor**

AWG/MCM	2
Compacto (mm <sup>2</sup> )	25

**Dimensions (mm)**

Diâmetro do Furo (mm)	10,5
L	20,0
A	82,0
CB	42,0
E	3,8
G	10,0

**Application Tool**

Alicate Mecânico (AT-60 4t)	
Matriz (IW)	162
Nº de Compressões	5
Alicate Hidráulico (AY-96 / CY-96)	
Matriz (IU)	162
Matriz (MH)	162A
Nº de Compressões	2

**Package**

Qtd / Emb	50
-----------	----

