

TBTA - BIMETALLIC COMPRESSION TERMINAL

TBTA-50-13

Description

Purpose: Bimetallic cable to busbar termination (aluminum or ALUMOSTEEL cable to copper busbar).

Characteristics: Compression connection. Its construction (copper pad and aluminum barrel) prevents the formation of galvanic corrosion. Pad with one hole.

Applications: Power distribution lines.

Material: Electrolytic copper pad and extruded aluminum barrel. Supplied with antioxidant compound INTELTROX.

Note: For installation in regions of aggressive environments, it is recommended to use thermoset insulation or self-fusing tape in the connection.

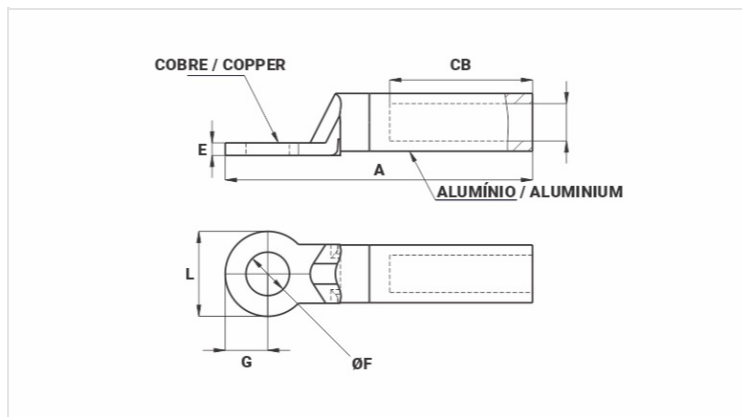

Datasheet

AAC Conductor

AWG/MCM	1/0
Compacto (mm ²)	50

Dimensions (mm)

Diâmetro do Furo (mm)	12,8
L	25,0
A	89,0
CB	42,0
E	3,8
G	12,5

Application Tool

Alicate Mecânico (AT-60 4t)	
Matriz (IW)	243
Nº de Compressões	4
Alicate Hidráulico (AY-96 / CY-96)	
Matriz (IU)	243
Matriz (MH)	243A
Nº de Compressões	2

Package

Qtd / Emb	50
-----------	----

