

**TBTA - BIMETALLIC COMPRESSION TERMINAL**

TBTA-185-10

**Description**

**Purpose:** Bimetallic cable to busbar termination (aluminum or ALUMOSTEEL cable to copper busbar).

**Characteristics:** Compression connection. Its construction (copper pad and aluminum barrel) prevents the formation of galvanic corrosion. Pad with one hole.

**Applications:** Power distribution lines.

**Material:** Electrolytic copper pad and extruded aluminum barrel. Supplied with antioxidant compound INTELTROX.

**Note:** For installation in regions of aggressive environments, it is recommended to use thermoset insulation or self-fusing tape in the connection.

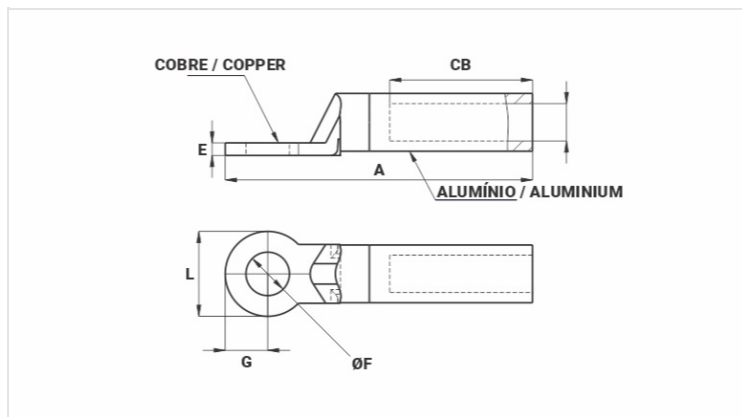

**Datasheet**

**AAC Conductor**

AWG/MCM	336,4
Compacto (mm²)	185

**Dimensions (mm)**

Diâmetro do Furo (mm)	10,5
L	32,0
A	120,0
CB	60,0
E	6,0
G	16,0

**Application Tool**

Alicate Mecânico (AT-60 4t)	
Matriz (IW)	-
Nº de Compressões	-
Alicate Hidráulico (AY-96 / CY-96)	
Matriz (IU)	316
Matriz (MH)	-
Nº de Compressões	3

**Package**

Qtd / Emb	15
-----------	----

