

**TTAC - ALUMINUM CABLE-BUSBAR TERMINAL (STRAIGHT CONNECTION)**

TTAC-1/0-250-4N

**Description**

**Purpose:** Cable to busbar termination for CA or CAA aluminum cables.

**Characteristics:** Mechanical connection. High electrical conductivity. Pad with two or four NEMA standard holes. There are lugs that lock the head of the screws.

**Application:** Power distribution lines and substations.

**Material:** Cast aluminum alloy and hot galvanized steel fittings.

**Application Tool:** Star or open-ended wrench.

**Note:** Using of the antioxiide compound INTELTROX is recommended.

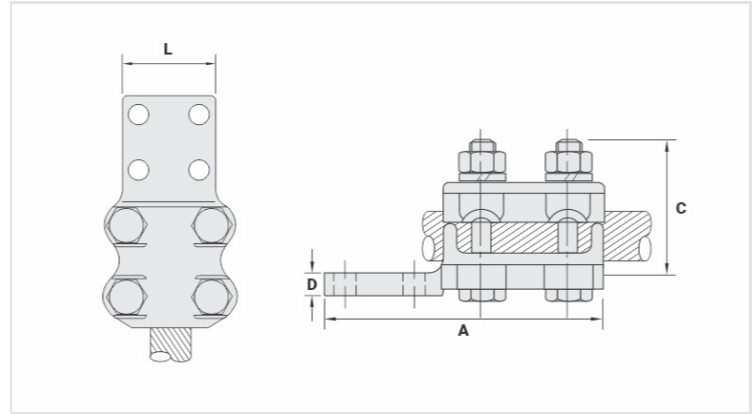

**Datasheet**

**Conductors**

CA (AWG/MCM)

1/0 - 250

CAA (AWG)

1/0 - 4/0

**Screw**

M12

**Dimensions**

L

78,0

A

150,0

C

60,0

D

10,0

Figura

3

**Package**

Qtd / Emb

10

Peso Unit. (g)

670,00