

TA - TIGHTENING TERMINAL (SYMMETRIC SERIES)

TA-6

Description

Purpose: Cable-busbar termination for copper cable (classes - 1/2/3). Connection to busbars, switchboards, electrical panels and others.

Characteristics: Mechanical pressure connection. Pad with one hole.

Application: Electrical installations in general (residential, building, industrial).

Material: Copper alloy terminal, electrolytic zinc plated steel nut.

Application Tool: Star or open-ended wrench.

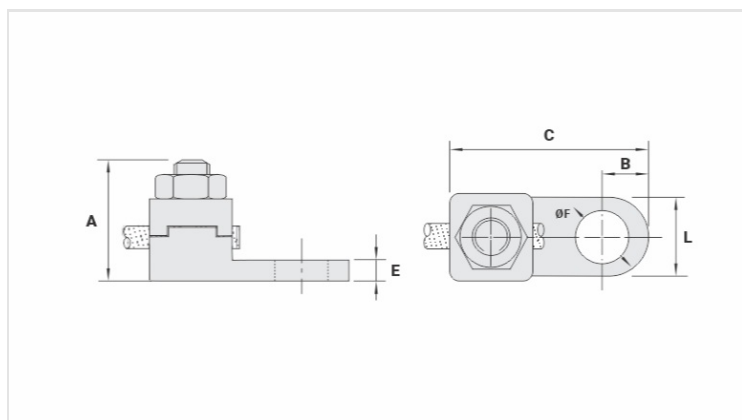

Datasheet

Conductor

mm ²	6
AWG/MCM	10

Screw

Pol.	3/16
Métrico	M5

Dimensions

L	11,0
A	21,0
C	28,0
B	5,5
E	3,0
ØF	5,4

Package

Qtd / Emb	100
Peso Unit. (g)	20,30