

TA - TIGHTENING TERMINAL (SYMMETRIC SERIES)

TA-25

Description

Purpose: Cable-busbar termination for copper cable (classes - 1/2/3). Connection to busbars, switchboards, electrical panels and others.

Characteristics: Mechanical pressure connection. Pad with one hole.

Application: Electrical installations in general (residential, building, industrial).

Material: Copper alloy terminal, electrolytic zinc plated steel nut.

Application Tool: Star or open-ended wrench.

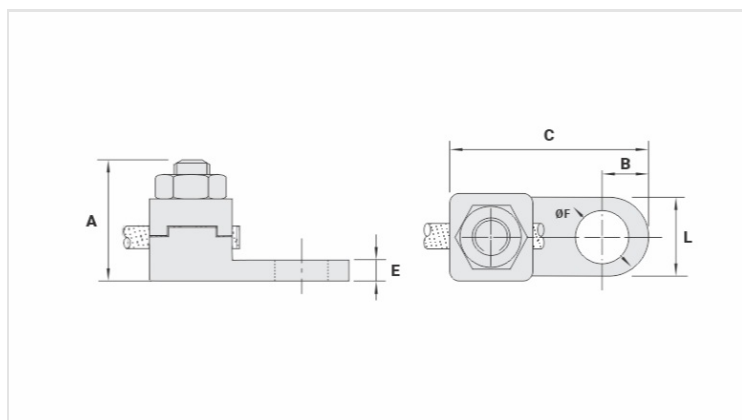

Datasheet

Conductor

mm ²	25
AWG/MCM	4

Screw

Pol.	1/4
Métrico	M6

Dimensions

L	13,5
A	24,0
C	32,0
B	7,0
E	4,0
ØF	6,5

Package

Qtd / Emb	50
Peso Unit. (g)	33,30