

**TA - TIGHTENING TERMINAL (SYMMETRIC SERIES)**

TA-70

**Description**

**Purpose:** Cable-busbar termination for copper cable (classes - 1/2/3). Connection to busbars, switchboards, electrical panels and others.

**Characteristics:** Mechanical pressure connection. Pad with one hole.

**Application:** Electrical installations in general (residential, building, industrial).

**Material:** Copper alloy terminal, electrolytic zinc plated steel nut.

**Application Tool:** Star or open-ended wrench.

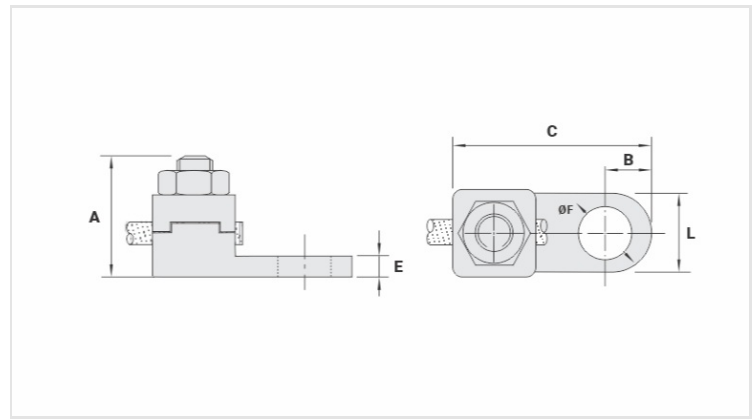

**Datasheet**

**Conductor**

mm <sup>2</sup>	70
AWG/MCM	2/0

**Screw**

Pol.	5/16
Métrico	M8

**Dimensions**

L	18,0
A	29,0
C	41,0
B	9,0
E	4,0
ØF	8,5

**Package**

Qtd / Emb	30
Peso Unit. (g)	61,00