

TA - TIGHTENING TERMINAL (SYMMETRIC SERIES)

TA-150

Description

Purpose: Cable-busbar termination for copper cable (classes - 1/2/3). Connection to busbars, switchboards, electrical panels and others.

Characteristics: Mechanical pressure connection. Pad with one hole.

Application: Electrical installations in general (residential, building, industrial).

Material: Copper alloy terminal, electrolytic zinc plated steel nut.

Application Tool: Star or open-ended wrench.

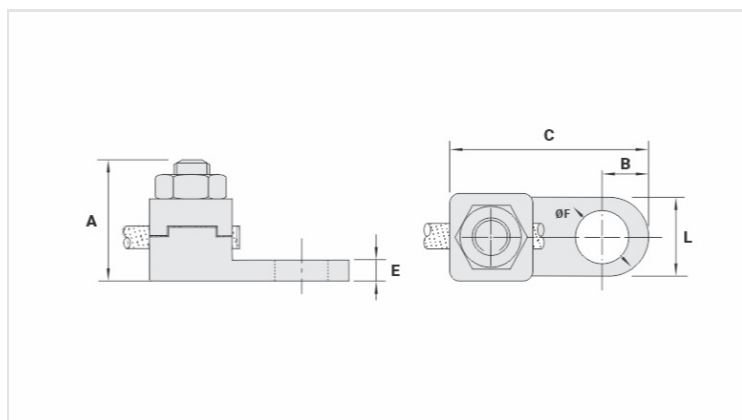

Datasheet

Conductor

mm ²	150
AWG/MCM	250

Screw

Pol.	1/2
Métrico	M12

Dimensions

L	24,5
A	41,0
C	59,5
B	12,5
E	5,0
ØF	13,5

Package

Qtd / Emb	20
Peso Unit. (g)	154,60