

**TA - TIGHTENING TERMINAL (SYMMETRIC SERIES)**

TA-300

**Description**

**Purpose:** Cable-busbar termination for copper cable (classes - 1/2/3). Connection to busbars, switchboards, electrical panels and others.

**Characteristics:** Mechanical pressure connection. Pad with one hole.

**Application:** Electrical installations in general (residential, building, industrial).

**Material:** Copper alloy terminal, electrolytic zinc plated steel nut.

**Application Tool:** Star or open-ended wrench.

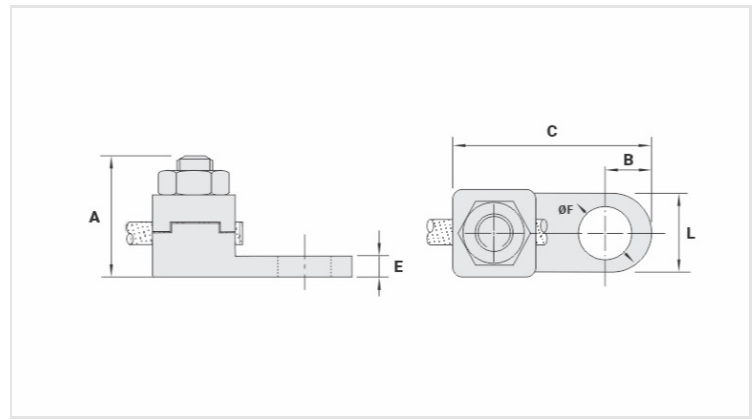

**Datasheet**

**Conductor**

mm <sup>2</sup>	300
AWG/MCM	600

**Screw**

Pol.	9/16
Métrico	M14

**Dimensions**

L	30,0
A	50,0
C	69,0
B	15,0
E	6,5
ØF	15,5

**Package**

Qtd / Emb	10
Peso Unit. (g)	228,60