

**TA - TIGHTENING TERMINAL (SYMMETRIC SERIES)**

TA-500

**Description**

**Purpose:** Cable-busbar termination for copper cable (classes - 1/2/3). Connection to busbars, switchboards, electrical panels and others.

**Characteristics:** Mechanical pressure connection. Pad with one hole.

**Application:** Electrical installations in general (residential, building, industrial).

**Material:** Copper alloy terminal, electrolytic zinc plated steel nut.

**Application Tool:** Star or open-ended wrench.

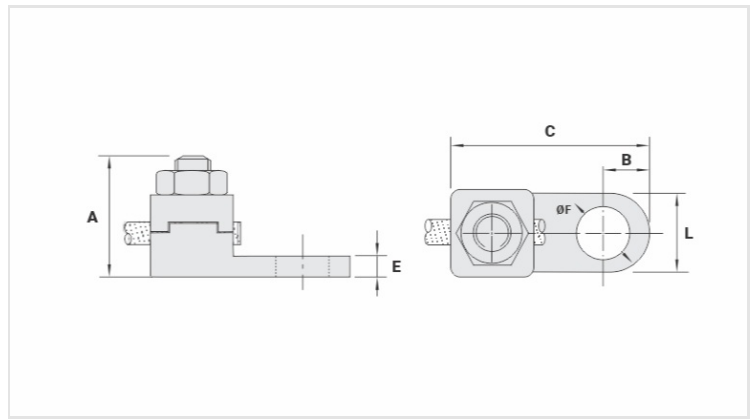

**Datasheet**

**Conductor**

mm <sup>2</sup>	500
AWG/MCM	1000

**Screw**

Pol.	5/8
Métrico	M16

**Dimensions**

L	39,0
A	61,0
C	94,0
B	19,5
E	9,0
ØF	18,0

**Package**

Qtd / Emb	8
Peso Unit. (g)	541,30