

**LF - SPLICE SLEEVE FOR COPPER CABLES (LOW TRACTION)**

LF-16

**Description**

**Purpose:** Rigid or flexible copper cable splice (low traction).

**Characteristics:** Compression connection. High electrical conductivity and corrosion resistance. Expanded shape ends for easy insertion of flexible conductors. With center wire stop.

**Application:** Electrical installations in general (residential, building, industrial).

**Material:** Electrolytic copper.

**Finish:** Tin plated.

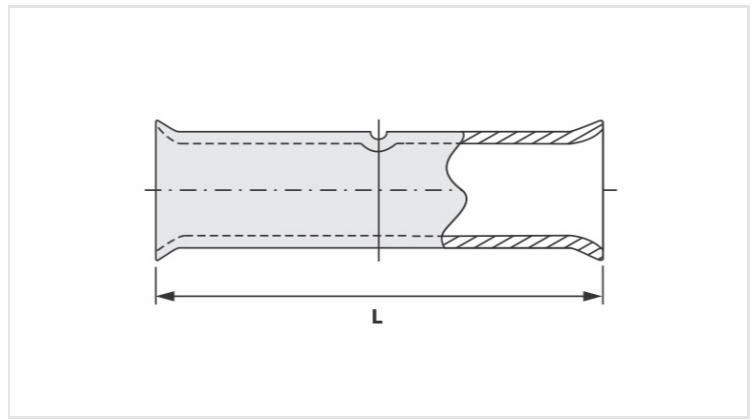

**Datasheet**

<b>Conductors - Cross Section (mm<sup>2</sup>)</b>	16
<b>Current (A)</b>	137
<b>Dimension (mm) - L</b>	34,0
<b>Application Tool</b>	
Alicates Mecânico	
Modelo	AT-60/68
Matriz (AT-60)	IW-5
Alicates Hidráulico (AY-96 / CY-96)	
Matriz Circunf.	IU-5
Matriz Hexagonal	H-5
<b>Package</b>	
Qtd / Emb	100
Peso Unit. (g)	6,80