

LF - SPLICE SLEEVE FOR COPPER CABLES (LOW TRACTION)

LF-185

Description

Purpose: Rigid or flexible copper cable splice (low traction).

Characteristics: Compression connection. High electrical conductivity and corrosion resistance. Expanded shape ends for easy insertion of flexible conductors. With center wire stop.

Application: Electrical installations in general (residential, building, industrial).

Material: Electrolytic copper.

Finish: Tin plated.

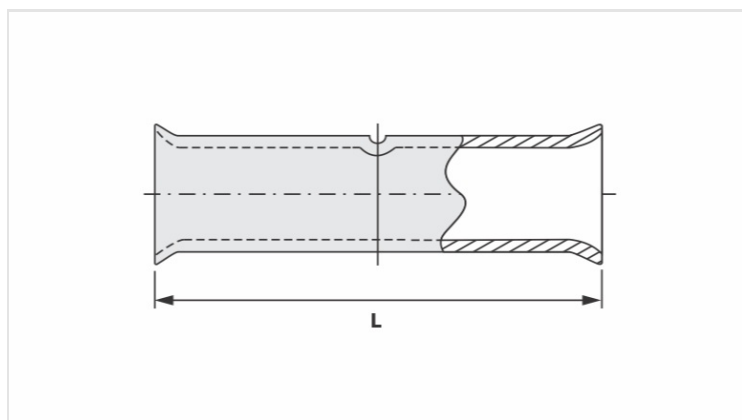

Datasheet

Conductors - Cross Section (mm²)	185
Current (A)	661
Dimension (mm) - L	58,5
Application Tool	
Alicate Mecânico	
Modelo	-
Matriz (AT-60)	-
Alicate Hidráulico (AY-96 / CY-96)	
Matriz Circunf.	IU-31
Matriz Hexagonal	H-31
Package	
Qtd / Emb	20
Peso Unit. (g)	63,80