

TH / TH-R - GROUNDING CLAMPS

TH-34-R

Description

Purpose: Connection between ground rod and cable. Suitable for COPPERSTEEL or copper cables.

Characteristics: Tightening connection. High electrical conductivity and corrosion resistance.

Application: Grounding systems in general (power distribution systems, grounding grids, residential, building and industrial grounding, grounding in telecommunication networks).

Material: Bronze clamp, copper alloy (TH-R) or copper alloy clamp, electrolytic zinc plated steel fittings (TH).

Application Tool: Spanner set or open-ended wrench.

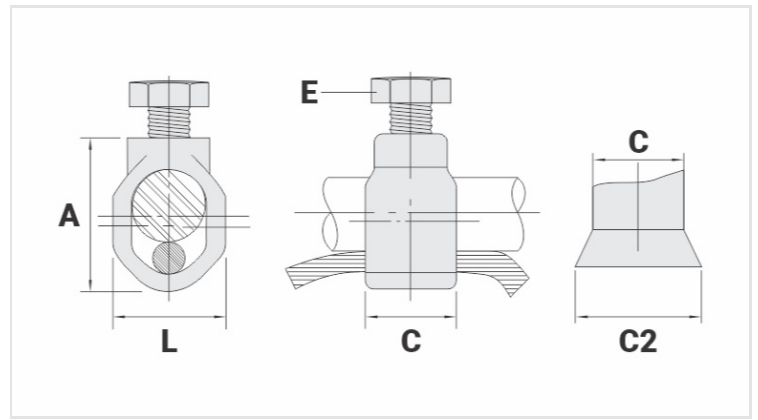

Datasheet

Ground Rod Nominal Diameter (inches)	3/4"
Conductor	
AWG/MCM	8 - 1/0
mm ²	10 - 50
Dimensions	
L	26,0
A	41,5
C	17,0
C2	21,0
Parafuso	M10
Package	
Qtd / Emb	40
Peso Unit. (g)	63,10