

**CADC - ALUMINUM WEDGE TYPE CONNECTOR**

CADC-104

**Description**

**Purpose:** CA or CAA aluminum and copper cables tap. Suitable for aluminum-aluminum and aluminum-copper connections.

**Characteristics:** Spring system connection (permanent tightening). High electrical conductivity and corrosion resistance.

**Application:** Power distribution lines.

**Material:** Aluminum alloy body and wedge. Supplied with antioxidant compound INTELTROX.

**Application Tool:** Impact tool with cartridge for wedge connector.

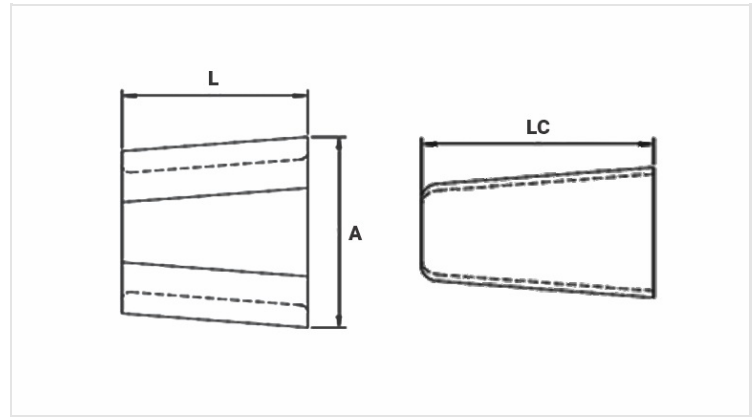

**Datasheet**

**Application Cartridge Color**

VERMELHO

**Conductors**

Principal

Min. (mm)

4,11

Máx. (mm)

6,55

AWG/MCM

6 | 4

Derivação

Min. (mm)

4,11

Máx. (mm)

5,84

AWG/MCM

6 | 6

Soma dos Condutores

Min. (mm)

8,41

Máx. (mm)

11,81

**Dimensions (mm)**

L

31,7

A

39,5

LC

38,0

**Package**

Qtd / Emb

50

Peso Unit. (g)

44,00

