

PF - SPLIT BOLT CONNECTOR

PF-25

Description

Purpose: Tap or splice (low traction) for COPPERSTEEL or copper cables. Suitable for copper to copper connection.

Characteristics: Tightening connection. High electrical conductivity and corrosion resistance.

Application: Power distribution network and grounding in general.

Material: Body in electrolytic copper. Nut and rider in copper alloy.

Finish: Tin plated.

Application Tool: Box, open-ended or monkey wrenches.

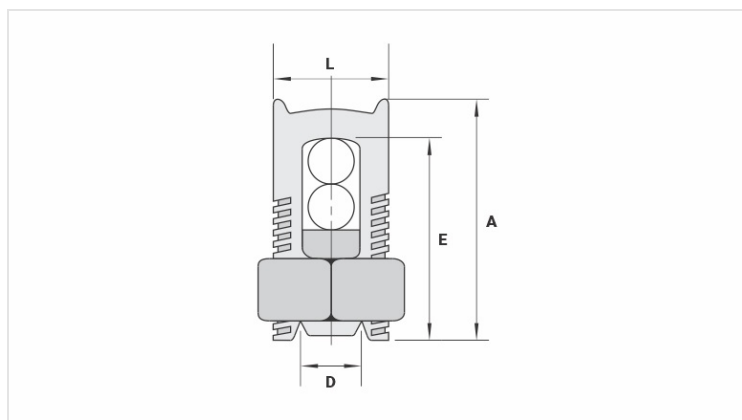

Datasheet

Conductors

Principal (mm²) 25

Derivação (mm²) 2,5 - 25

Dimensions (mm)

L 17,0

A 26,5

C 14,7

D 6,8

E 27,0

Package

Qtd / Emb 50

Peso Unit. (g) 33,60