

PF - SPLIT BOLT CONNECTOR

PF-35

Description

Purpose: Tap or splice (low traction) for COPPERSTEEL or copper cables. Suitable for copper to copper connection.

Characteristics: Tightening connection. High electrical conductivity and corrosion resistance.

Application: Power distribution network and grounding in general.

Material: Body in electrolytic copper. Nut and rider in copper alloy.

Finish: Tin plated.

Application Tool: Box, open-ended or monkey wrenches.

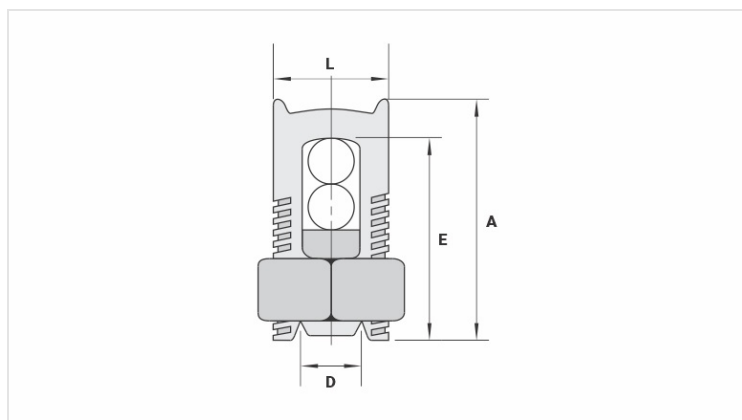

Datasheet

Conductors

Principal (mm²) 35

Derivação (mm²) 2,5 - 35

Dimensions (mm)

L 19,0

A 29,0

C 15,6

D 7,9

E 29,0

Package

Qtd / Emb 50

Peso Unit. (g) 42,00