

PF - SPLIT BOLT CONNECTOR

PF-95

Description

Purpose: Tap or splice (low traction) for COPPERSTEEL or copper cables. Suitable for copper to copper connection.

Characteristics: Tightening connection. High electrical conductivity and corrosion resistance.

Application: Power distribution network and grounding in general.

Material: Body in electrolytic copper. Nut and rider in copper alloy.

Finish: Tin plated.

Application Tool: Box, open-ended or monkey wrenches.

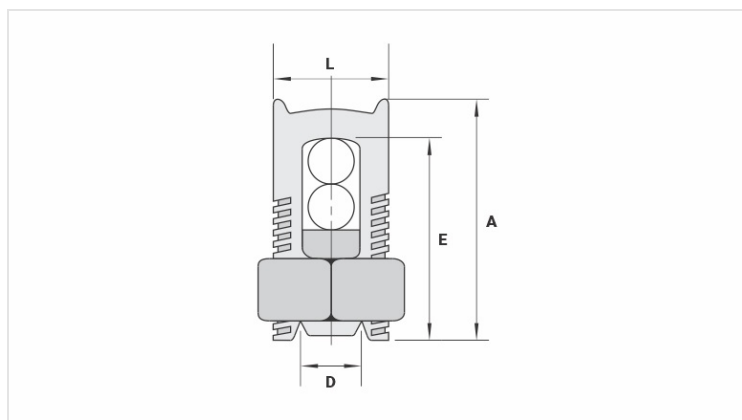

Datasheet

Conductors

Principal (mm²) 95

Derivação (mm²) 25 - 95

Dimensions (mm)

L 28,0

A 45,0

C 24,8

D 13,5

E 45,0

Package

Qtd / Emb 20

Peso Unit. (g) 136,80