

**PF - SPLIT BOLT CONNECTOR**

PF-185

**Description**

**Purpose:** Tap or splice (low traction) for COPPERSTEEL or copper cables. Suitable for copper to copper connection.

**Characteristics:** Tightening connection. High electrical conductivity and corrosion resistance.

**Application:** Power distribution network and grounding in general.

**Material:** Body in electrolytic copper. Nut and rider in copper alloy.

**Finish:** Tin plated.

**Application Tool:** Box, open-ended or monkey wrenches.

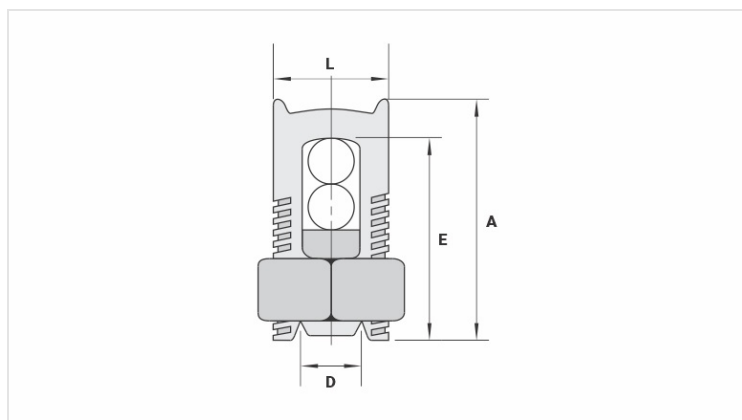

**Datasheet**

**Conductors**

Principal (mm<sup>2</sup>) 185

Derivação (mm<sup>2</sup>) 50 - 185

**Dimensions (mm)**

L 31,0

A 57,0

C 30,0

D 17,8

E 56,0

**Package**

Qtd / Emb 10

Peso Unit. (g) 238,50