

PFB - BIMETALLIC SPLIT BOLT CONNECTOR WITH SPACER

PFB-35

Description

Purpose: Tap or splice (low traction) for COPPERSTEEL, copper or aluminum cables. Suitable for copper to copper, copper to aluminum and aluminum to copper connections.

Characteristics: Tightening connection. High electrical conductivity and corrosion resistance. Allows bimetallic connection.

Application: Power distribution lines and grounding in general.

Material: Body in eletrolytic copper, nut, rider and spacer in copper alloy.

Finish: Tin plated.

Application Tool: Box open-ended or monkey wrenches.

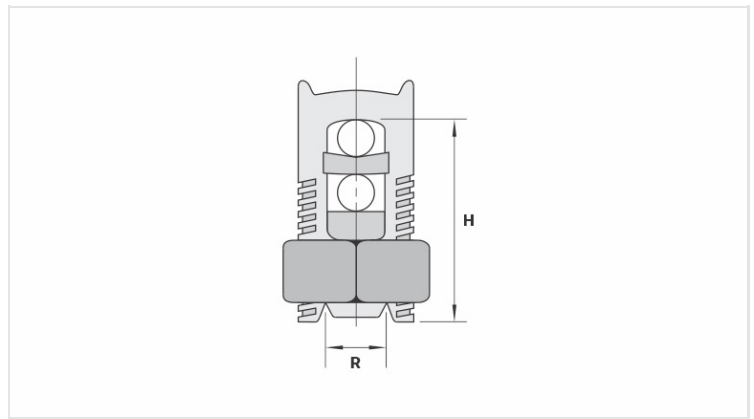

Datasheet

Conductors

Principal (mm²) 35

Derivação (mm²) 4 - 35

Dimensions (mm)

L

A

C

D

E

Package

Qtd / Emb 50

Peso Unit. (g) 49,50